

High-Resolution Tandem Mass Spectrometer (MS/MS) of Increased Sensitivity and Mass Range^{1a}

Fred W. McLafferty,* Peter J. Todd, Donald C. McGilvery, and Michael A. Baldwin^{1b}

Contribution from the Department of Chemistry, Baker Laboratory, Cornell University, Ithaca, New York 14853. Received November 20, 1979

Abstract: An MS/MS instrument is described in which 10-keV ions representing mixture components are separated (MS-I) by high resolution (50 000). The separated primary ions can be accelerated then to 30 keV; these undergo collisional activation (CA) with a molecular He beam <0.1 mm wide. The resulting CA spectrum is measured by mass analysis (MS-II) with an electrostatic analyzer. Sensitivity is greatly improved over previous CA systems, with 6% of 10-keV and 11% of 25-keV CH₄⁺ ions transformed into collectable product ions. The mass range for ions on which CA spectra can be determined is greatly extended, with an upper limit of *m/z* 900 for 8-keV primary ions and *m/z* 3600 for 2-keV ions, for which acceleration can give >10 keV collision energies for CA spectra. Unique applications for trace component analysis in complex molecular mixtures, molecular structure determination, and fundamental ion chemistry studies are described.

Tandem mass spectrometry (MS/MS)² is a promising new tool for trace-component identification and quantitation in complex organic mixtures.²⁻⁴ Analogous to separation/identification systems combining gas and liquid chromatography with mass spectrometry (GC/MS⁵ and LC/MS⁶), MS-I of the MS/MS system separates a particular mass value of ions which will include those corresponding to the desired mixture component. Dissociation of the separated ions, usually by collisional activation (CA),⁷ yields a secondary mass spectrum of product ions measured by MS-II which can be used for specific determination of the desired component. Advantages found for MS/MS, such as those from specific ion monitoring²⁻⁴ and computer automation,⁸ are similar to those of GC/MS and LC/MS. However, less volatile compounds can be determined by MS/MS than by GC/MS, and the much faster separation with MS/MS makes possible shorter analysis times (>50/h)⁹ than by GC/MS or LC/MS.

Most MS/MS studies to date have been carried out with reversed-geometry^{8,10} or linked-scanning¹¹ double-focusing instruments. Recently the tandem quadrupole has been shown to be very promising, particularly for routine MS/MS analyses.^{9,12,13} We describe here a double-focusing MS/MS instrument proposed earlier¹⁴ with a unique molecular beam collision region. The greatly increased capabilities of this instrument with respect to resolution, sensitivity, and mass range promise important applications in fundamental ion chemistry studies, molecular structure determination, and trace component analysis in complex molecular mixtures. Recently other "triple-analyzer" instruments with high-resolution MS-I but without specific CA capabilities have been described for ion photodissociation¹⁶ and metastable ion dissociation¹⁷ studies.¹⁸ No results are available as yet from an announced commercial triple-analyzer with a conventional collision chamber (Figure 2A).¹⁹

Experimental Section

In the instrument (Figure 1) ions generated by electron or chemical ionization are separated in the first double-focusing mass spectrometer (MS-I), an Hitachi RMH-2 with a usable resolution of >50 000.¹⁵ These ions, normally of 10-keV kinetic energy, can be accelerated to 30 keV in the triple-element lens A, which also serves to refocus the ions onto the collision gas beam. The schematic (Figure 2B) shows a top view of the vertical ion beam ribbon, oriented orthogonally to the vertical collision gas beam flowing through a 25- μ m slit from a 1-Torr source through the ion beam into an opposing skimmer slit at the entrance to a 7000 L/s diffusion pump. Helium was used as the collision gas in these experiments.²⁰ The ion beam region for 35 mm on either side of the helium beam is differentially pumped with a 2500 L/s diffusion pump; further differential pumping (400 and 2500 L/s)

in the ion lens regions results in operating pressures there of <3 \times 10⁻⁶ Torr. The resulting He beam profile gives 95% of the ion collisions in a distance of <1 mm. The CA ionic products are focused onto the entrance slit of MS-II with ion lens B; with a 200- μ m slit width and 0.8° divergence half-angle its measured depth of field is 3 mm. The focusing properties of lens B are highly energy dependent; changing the center element potential by 1% from the optimum reduces the transmitted ion signal by 50%. At present an electrostatic analyzer (and lens B) serves as MS-II. Computer-controlled scanning of its potential, in a constant ratio to the focus potential of lens B, yields the CA spectrum using ion detection after the β' slit. The computer system for data acquisition and spectrum averaging is similar to that described earlier.⁸ The data below are for operation of the instrument in this configuration. Installation of Magnet-II is in progress.

Results and Discussion

MS-I Resolution. The double-focusing MS-I greatly reduces the problem of interfering primary ions, giving advantages similar to those found in employing high-resolution capillary GC in GC/MS.⁵ In Figure 3 the isobaric ions C₆H₅N⁺ (*m/z* 91.042) and C₇H₇⁺ (91.055) differ in mass by 1:7280, yet their corresponding CA spectra can be determined with <2% cross-interference (the CA spectra of the pure ions are identical within experimental error to those shown; Figure 4 shows a partial CA spectrum of pure C₇H₇⁺ ions measured under similar conditions). Such a separation capability is especially valuable for isobaric ions yielding similar CA spectra. The CA spectra of the C₇H₇⁺ isomeric benzyl and tropylium ions are best distinguished²¹ by their values of [*m/z* 77]/[*m/z* 74], 4 and 0.5, respectively. Obviously, contamination of the separated C₇H₇⁺ with the C₆H₅N⁺ ions would give erroneously low values for [benzyl⁺]/[tropylium⁺].

This capability is also useful for molecular-structure determination; the CA spectrum of C₃H₅O⁺ (*m/z* 57.034) formed from 5-methyl-3-hexanone shows <1% cross-contamination for the equally abundant isobaric ion C₄H₉⁺ (*m/z* 57.070) separated at 10 000 resolution (Figure 5). Comparison with reference spectra of six distinguishable C₃H₅O⁺ isomers²² provides definitive evidence for the presence of CH₃CH₂CO- in this compound.

Sensitivity of CA Spectra. In most CA instruments the high-energy ions are passed through a collision chamber containing a gas such as helium at \sim 10⁻⁴ Torr (shown schematically in Figure 2A). The gas must escape through the ion entrance and exit of the collision chamber, producing gas plumes in either direction from the chamber along the ion beam. Thus even with a minimum-width chamber^{10,18} a substantial proportion of the collisions occurs outside the region of optimum focusing for the product CA ions. In such a collision system⁸

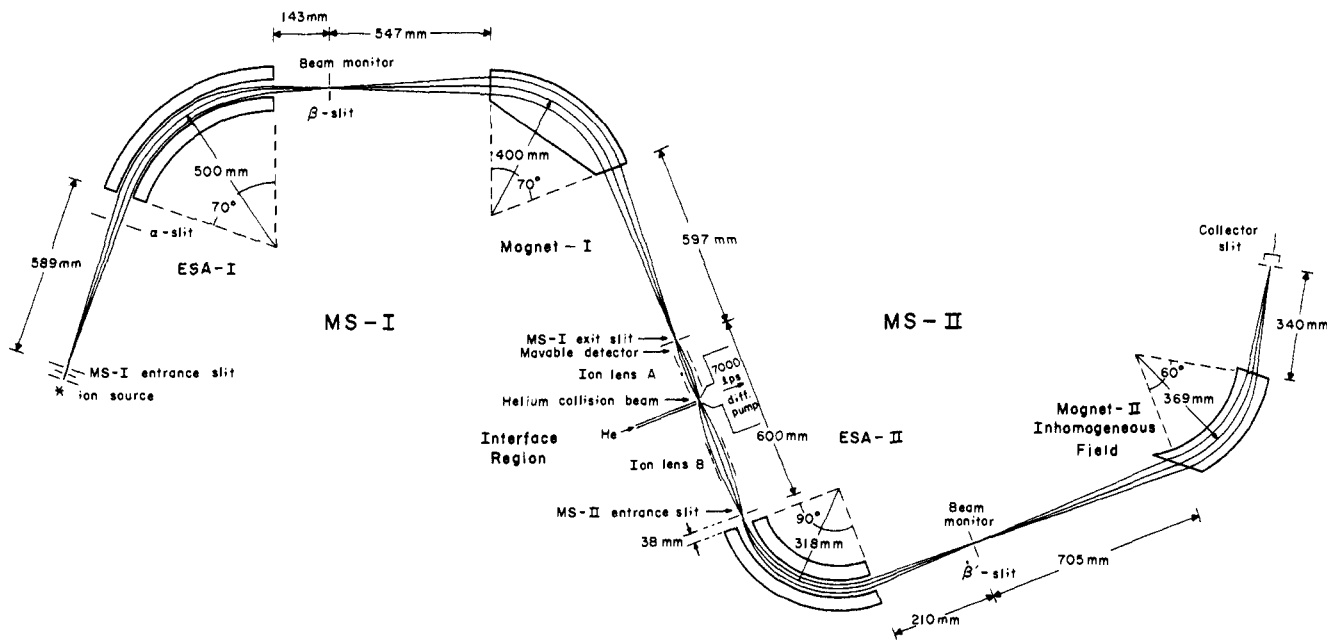

Figure 1. High-resolution MS/MS instrument.

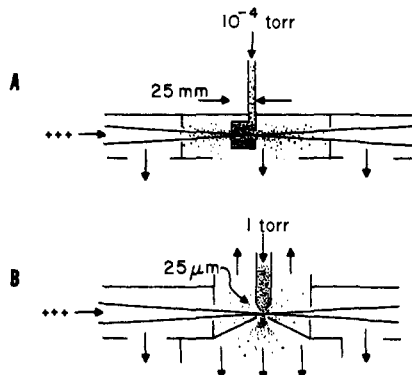

Figure 2. Collisional activation (schematic) of an ion beam (entering left) using (top) a 25-mm long chamber at 10^{-4} Torr target gas pressure; (bottom) a molecular beam of target gas from a 25- μm slit.

<0.5% of 8-keV kinetic energy CH_4^+ ions can be converted into collectable C^+-CH_3^+ product ions. This situation was simulated in the new instrument by turning off the central 7000 L/s pump, greatly reducing the pressure gradient along the ion beam away from the center of the central 70-mm region. Under these conditions a maximum of $0.9 \pm 0.2\%$ of 10-keV CH_4^+ ions can be converted into collectable C^+-CH_3^+ product ions. However, with the molecular beam collision region this value is increased by a factor of ~ 7 (Figure 6). In addition the average CA conversion efficiency can be increased to $\sim 11\%$ by increasing the ion kinetic energy to 25 keV (Figures 4 and 6). The abundance increase is even greater for CA product ions from high-energy reactions,^{8,20} in the CA spectra of C_7H_7^+ ions from toluene (Figure 4) compare the change in relative and absolute yields of C_6H_5^+ and C_6H_2^+ , appearance energies 15 and 21 eV,¹⁵ respectively, in increasing the ion kinetic energy from 5 to 25 keV.

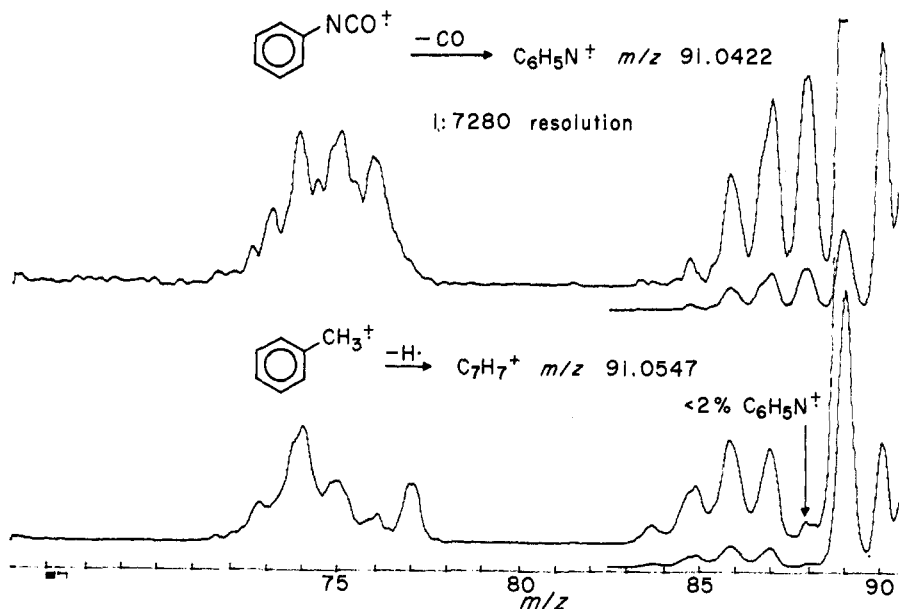

Figure 3. CA spectra (five scan average) of 10-keV $\text{C}_6\text{H}_5\text{N}^+$ and C_7H_7^+ ions formed by 70-eV electron ionization of a mixture of phenyl isocyanate and toluene and separated with an MS-I resolution of $\sim 12\,000$.

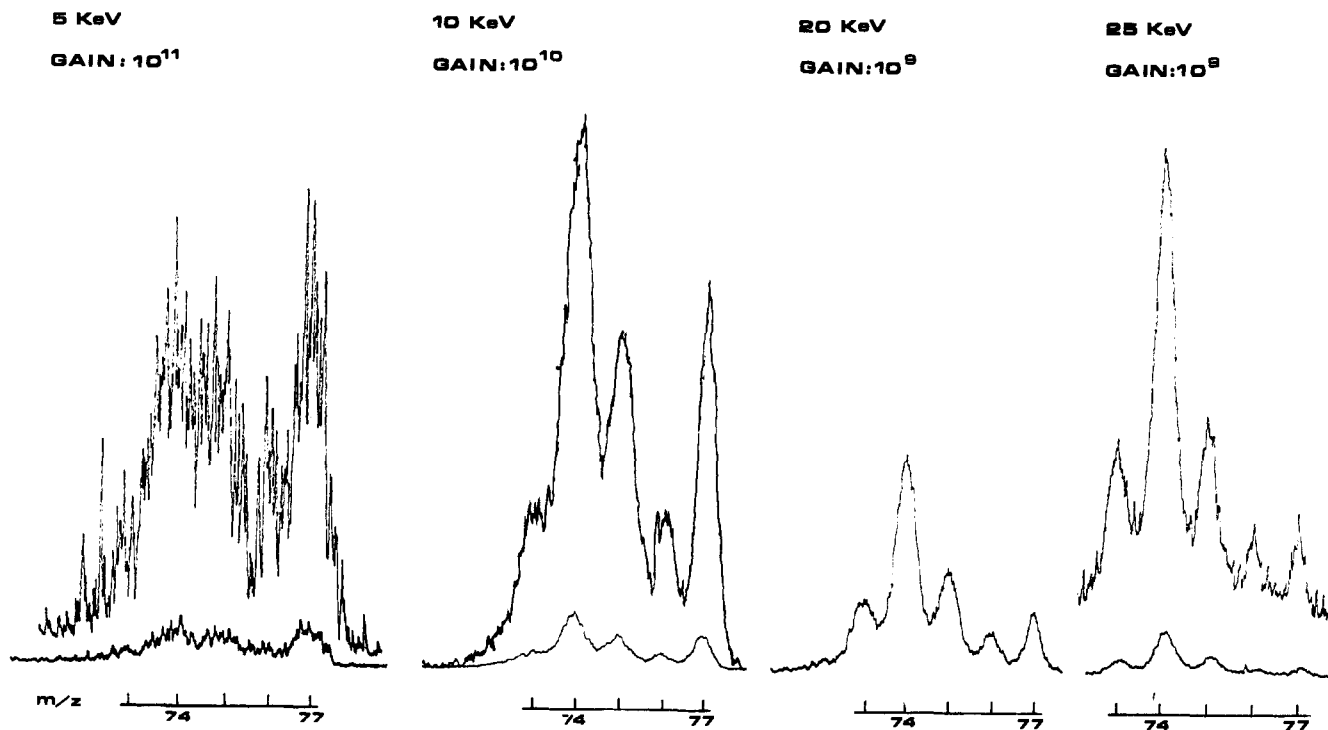

Figure 4. Effects of precursor ion kinetic energy on m/z 73-77 of the CA spectrum of $C_7H_7^+$ ions from the 70-eV electron ionization of toluene. Identical sample pressure and ion source conditions were used for each spectrum; the gains refer to the upper traces.

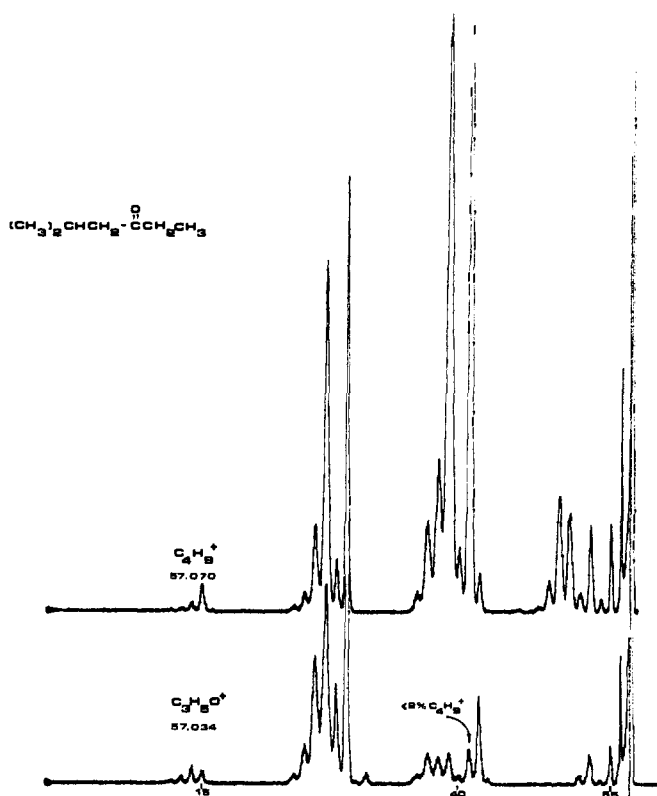

Figure 5. Single-scan CA spectra of $C_4H_9^+$ and $C_3H_5O^+$ ions formed in nearly equal abundances by the 70-eV electron ionization of 3-heptanone.

The double ion lens system also improves signal/noise by discriminating against ions of energies other than those desired; this has eliminated "ghost" peaks²³ from the CA spectra. The single-scan spectra of Figure 5 also illustrate the overall sensitivity gain, with signal/noise superior to that obtained from a conventional instrument^{8,22} by averaging 20 scans.

This improved sensitivity can be useful for ion-structure determination. Although the singly charged ions in the CA spectra of the isomeric propene and cyclopropane ions are identical within experimental error, we find that these ions can be reliably distinguished based on $C_3H_5^{2+}$, which represent 0.14 and 0.08%, respectively, of the total fragment ion abundances in the CA spectra.²⁴

Ion Chemistry Studies. The high-sensitivity collision region and its preceding ion-accelerating lens also make possible the direct measurement of CA spectra of neutral products from ion reactions.²⁵ The CA spectrum of Figure 7 resulted from focusing MS-I to transmit acetone molecular ions, causing some of these to undergo CA decomposition just before the MS-I exit slit with an air leak, and preventing any ions from entering the collision region by imposing a 6-kV potential on one of the center elements of ion lens A. Thus this CA spectrum should be produced by collisional ionization of the neutral products from the acetone ion collisions occurring between magnet-I and lens A. The m/z 58 peak apparently arises from acetone molecules produced by charge exchange. Without the air leak the decompositions of metastable acetone ions produced a similar CA neutrals spectrum except that it showed no m/z 58 peak and a lower signal/noise. The neutrals are *not* focused onto the collision region; the data indicating $[CH_3CO\cdot] > [CH_3\cdot]$ may arise from a much greater transmission efficiency for the acetyl radicals, as the complementary ions produced in the CA decomposition show $[CH_3CO^+] > [CH_3^+]$.

Field ion kinetics measurements²⁶ provide unique information on ion decompositions in the picosecond range, but only for ions formed under such relatively low energy conditions. This system (Figure 2B) should make similar studies possible for precursor ions of high internal energy resulting from CA. The ion beam width can be reduced to 10 μm with the MS-I exit slit, and made to pass within a beam width of the gas slit, so that with a collision gas slit of 10 μm the majority of ion collisions should occur within $\sim 10 \mu m$ along the ion path. A 25-keV ion of m/z 100 travels this distance in 4×10^{-12} s; ion lifetime measurements should be possible by imposing a po-

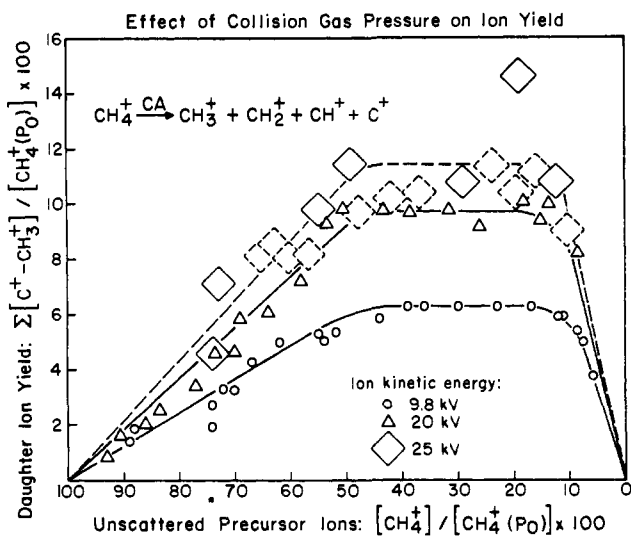

Figure 6. Effect of helium collision gas pressure, measured as the abundance of transmitted precursor CH_4^+ ions relative to that without collision gas, on the total product ion (C^+ , CH^+ , CH_2^+ , CH_3^+) abundance relative to the precursor ion abundance without collision gas. The 25-keV ion data (two separate runs) may be more erratic because of occasional electrical breakdown in the ion lens.

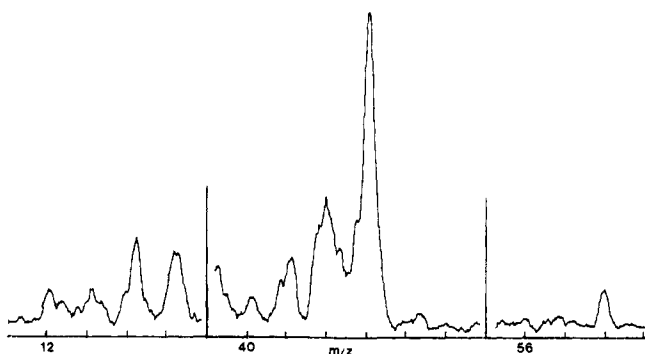

Figure 7. CA spectrum (20 scans) of the neutral products resulting from the collision of 10-keV acetone cations with air molecules near the MS-I exit slit.

tential difference across the collision region²⁶ or detecting fluorescence emitted at 90° to the ion beam.^{27,28}

Upper Mass Limit of MS-I. Increasing collisional energies by increasing the MS-I ion accelerating potential reduces the maximum m/z value focused by the magnet. Our reversed-geometry CA instrument⁸ is seriously limited in that its maximum mass for 8-kV ions is m/z 125. This is increased to m/z 900 in MS-I of the present instrument, whose magnet has a higher radius and field. Further, m/z 3600 ions of 2-keV energy can be separated by MS-I and accelerated to collision energies of >10 keV. This appears to be of particular value for fragment ion characterization to aid structure determination of large molecules and for sequencing complex oligopeptide mixtures.

MS-II Resolution. CA spectra measured with energy analyzers, such as that used in MS-II, show poor resolution because the energy released in the reaction coordinate is added or subtracted (depending on the decomposing ion orientation) from the total kinetic energy of the ion. Increasing the total energy makes the energy released a smaller fraction, improving the resolution of the resulting CA spectrum (Figure 4).³⁰ A second magnet will make MS-II double focusing; the added

energy focusing will compensate for the differing ion energies arising in CA, which should increase the resolution of CA spectra measured on MS-II >10 000.

Note Added in Proof. Spectra have recently been obtained from the completed tandem double-focusing instrument of Figure 1.

Acknowledgment. Valuable help was given by Henk Boerboom, Peter Derrick, and Richard F. Porter in design and by Michael P. Barbalas, Suen Kit-Man, Gregory J. Wendel, and Michael R. Wixom in construction and testing of this instrument. Generous financial support was provided by the National Institutes of Health and the Army Research Office, Durham.

References and Notes

- (1) (a) Collisional Activation and Metastable Ion Characteristics. 73, Part 72: ref 4. (b) Visiting scientist from the School of Pharmacy, University of London.
- (2) McLafferty, F. W.; Bockhoff, F. M. *Anal. Chem.* **1978**, *50*, 69-76.
- (3) Kruger, T. L.; Litton, J. F.; Kondrat, R. W.; Cooks, R. G. *Anal. Chem.* **1976**, *48*, 2113. Kondrat, R. W.; Cooks, R. G. *Ibid.* **1978**, *50*, 81A. Zakett, D.; Schoen, A. E.; Kondrat, R. W.; Cooks, R. G. *J. Am. Chem. Soc.* **1979**, *101*, 6783.
- (4) McLafferty, F. W. *Acc. Chem. Res.* **1980**, *13*, 33-9.
- (5) Burlingame, A. L.; Shackleton, C. H. L.; Howe, I.; Chizhov, S. *Anal. Chem.* **1978**, *50*, 364R.
- (6) Dawkins, B. G.; McLafferty, F. W. In "GLC and HPLC Determination of Therapeutic Agents", Tsuji, K., Morozowich, W., Eds.; Marcel Dekker: New York, 1978; Vol. 1, pp 259-275. Arpino, P. J.; Guiochon, G. *Anal. Chem.* **1979**, *51*, 682A.
- (7) McLafferty, F. W.; Bente, P. F. III; Kornfeld, R.; Tsai, S.-C.; Howe, I. *J. Am. Chem. Soc.* **1973**, *95*, 2120. McLafferty, F. W.; Kornfeld, R.; Haddon, W. F.; Levens, K.; Sakai, I.; Bente, P. F. III; Tsai, S.-C.; Schuddehage, H. D. *R. Ibid.* **1973**, *95*, 3886.
- (8) Wachs, T.; Van de Sande, C. C.; Bente, P. F. III; Dymerski, P. P.; McLafferty, F. W. *Int. J. Mass Spectrom. Ion Phys.* **1977**, *23*, 21.
- (9) Glish, G. L.; Unger, S. E.; Schoen, A. E.; Zakett, D.; Ridley, T. Y.; Cameron, D.; Sigsby, M. L.; Kruger, T. L.; Cooks, R. G. "Abstracts of Papers", 178th National Meeting of the American Chemical Society, Washington, D.C., Sept. 1979; American Chemical Society: Washington, D.C., 1979; ANAL 95.
- (10) Cooks, R. G.; Beynon, J. H.; Caprioli, R. M.; Lester, G. R. "Metastable Ions"; Elsevier: Amsterdam, 1973.
- (11) Beynon, J. H.; Cooks, R. G. *Int. J. Mass Spectrom. Ion Phys.*, **1976**, *19*, 107. Weston, A. F.; Jennings, K. R.; Evans, S.; Elliott, R. M. *Ibid.* **1976**, *20*, 317.
- (12) (a) Yost, R. A.; Enke, C. G. *J. Am. Chem. Soc.* **1978**, *100*, 2274. (b) *Anal. Chem.* **1979**, *51*, 1251A.
- (13) Hunt, D. F.; Buko, A. M.; Ballard, J.; Shabanowitz, J., 27th Conference on Mass Spectrometry and Allied Topics, Seattle, June 1979, Paper FAMOB5. Hunt, D. F.; Shabanowitz, J.; Giordani, A. *Ibid.*, Paper FAMOC2.
- (14) McLafferty, F. W. In "Analytical Pyrolysis"; Jones, C. E. R., Cramers, C. A., Eds.; Elsevier: Amsterdam, 1977; pp 39-48.
- (15) Baldwin, M. A.; McLafferty, F. W.; Jerina, D. M. *J. Am. Chem. Soc.* **1975**, *97*, 6169-6174.
- (16) Russell, D. H.; Smith, D. H.; Warmack, R. J. Reference 9, Paper ANAL 96.
- (17) Vrscaj, V.; Kramer, V.; Medved, M.; Kralj, B.; Marsel, J.; Beynon, J. H.; Ast, T., submitted for publication in *Int. J. Mass Spectrom. Ion Phys.*
- (18) Another "triple analyzer" does not have double-focusing geometry: Maquestiau, A.; Van Haverbeke, Y.; Flammang, R.; Abrassart, M.; Finet, D. *Bull. Soc. Chim. Belg.* **1978**, *87*, 765.
- (19) Kratos-AEI, Manchester, England.
- (20) Kim, M. S.; McLafferty, F. W. *J. Am. Chem. Soc.* **1978**, *100*, 3279.
- (21) McLafferty, F. W.; Bockhoff, F. M. *J. Am. Chem. Soc.* **1979**, *101*, 1783-1786.
- (22) McLafferty, F. W.; Dymerski, P. P., unpublished results.
- (23) Ast, T.; Bozorgzabeh, M. H.; Wiebers, J. L.; Beynon, J. H.; Brenton, A. G. *Org. Mass Spectrom.* **1979**, *14*, 313.
- (24) Bowen, R. D.; Barbalas, M. P.; Pagano, F. P.; Todd, P. J.; McLafferty, F. W. *Org. Mass Spectrom.* **1980**, *15*, 51.
- (25) Marinelli, W. J.; Morton, T. H. *J. Am. Chem. Soc.* **1978**, *100*, 3536.
- (26) Derrick, P. J.; Burlingame, A. L. *Acc. Chem. Res.* **1974**, *7*, 328.
- (27) Park, J. T. In "Collision Spectroscopy", Cooks, R. G., Ed.; Plenum Press: New York, 1978; p 19.
- (28) Using such techniques to produce most collisions in a correspondingly small cross-sectional area should have substantial advantages for exploitation of the very exciting new development of angle-resolved CA mass spectra.²⁹
- (29) Laramee, J. A.; Hemberger, P. H.; Cooks, R. G. *J. Am. Chem. Soc.* **1979**, *101*, 6460.
- (30) An elegant instrument with single-focusing MS-I but with 40-kV post-CA acceleration and multichannel ion detection gives impressive MS-II resolution: Louter, G. J.; Boerboom, A. J. H.; Stalmeier, P. F. M.; Tuihof, H. H.; Kistemaker, J., submitted for publication.